

MODEL NUMBER: SG1914-1-1-GB-XX

# IMPROX SUPAGATE PLUS

## ImproX SupaGate Weatherproof Plus 4-Channel Controller INSTALLATION MANUAL

### SPECIFICATIONS

<b>Working Environment</b> .....	The SupaGate Weatherproof is designed to work in an indoor or protected outdoor environment similar to IP66. The SupaGate is, therefore, sealed against water (refer to the section "MOUNTING THE SUPAGATE WEATHERPROOF PLUS").	
<b>Passive Frequency</b> .....	125 kHz.	
<b>RF Frequency</b> .....	433.92 MHz.	
<b>Security</b> .....	ImproX DCT, Dynamic Code Transmission Technology.	
<b>Input Voltage</b> .....	10 V DC to 14 V DC.	
<b>Power Requirements</b>	<b>Current (mA)</b>	<b>Power (W)</b>
Input Voltage 12 V DC, 1 Antenna Reader, all Relays OFF .....	60	0.72
Input Voltage 12 V DC, 1 Antenna Reader, all Relays ON .....	220	2.64
Input Voltage 12 V DC, 2 Antenna Readers, all Relays OFF .....	100	1.2
Input Voltage 12 V DC, 2 Antenna Readers, all Relays ON .....	260	3.12
<b>Relays</b>		
Relay Output .....	4 Relays, each with NO, COM and NC contacts.	
Relay Contact Ratings .....	10 A at 28 V DC, 5 A at 220 V AC.	

## Installer Interfaces

LED Indicators

7-Segment Display ..... 2 Displays, Red (internally visible).

Push-buttons ..... 4 Push-buttons (internally accessible).

## INSTALLATION INFORMATION

### Accessories

Find the following when unpacking the SupaGate Weatherproof Plus Controller:

- A SupaGate Weatherproof Plus housed in a Light Grey Polycarbonate Plastic housing. The housing consists of a Lid and Base held together with four M4 x 24 mm, slotted screws. The SupaGate's electronics are enclosed in a Black tinted, Polycarbonate Plastic Cabinet, consisting of a 2-piece Top Cover and a Base.
- A 433.92 MHz, 185 mm (7 in) Antenna.

**CAUTION: DO NOT use the Metal-oxide Varistors (25 Vrms, 500 A, 77 V max clamping) with mains power applications.**

- Four Metal-Oxide Varistors, 25 Vrms, 500 A, 77 V max clamping.
- A 1 m (3 ft) Antenna Reader Connection Cable, with a 6-Way Friction Lock Header Connector at one end.
- Four Brass Wood Screws (3.50 mm x 25 mm).
- Four Wall Plugs (7 mm).
- An extra Serial Number Label.

### General

Remember the following when installing the SupaGate Weatherproof Plus:

#### Read Range

**CAUTION: The SupaGate Weatherproof Plus is susceptible to excessive RF interference, reducing the range. Always site test the SupaGate Weatherproof Plus, prior to installation, in its installation location for optimum RF read range.**

- The SupaGate Weatherproof Plus has a tested RF read range of between 10 m to 30 m (11 yd to 33 yd) when used with the ImproX QT (XQT904-1-1-GB-XX).
- The passive read range varies from between 25 mm to 76 mm (1 in to 3 in) depending on the Antenna Reader and Tag used.

#### Antenna Reader Distance

The ideal cable distance between the SupaGate Weatherproof Plus and its Antenna Reader ranges between 2 m to 16 m (7 ft to 53 ft). Achieve this by using good quality screened, twisted pair cable.

## Distance between Antenna Readers from the SAME SupaGate Weatherproof Plus

To avoid mutual interference, install the Antenna Readers alongside each other at least 150 mm (6 in) apart.

## Distance between Antenna Readers from DIFFERENT SupaGates

To avoid mutual interference, install the Antenna Readers alongside each other at least 500 mm (20 in) apart.

## Default Relay Selection

- For passive Tags presented to Antenna Reader 1, Relay 1 is automatically selected. For passive Tags presented to Antenna Reader 2, Relay 2 is automatically selected.
- When using the Normal (4-Digit) PIN-code, if you enter the PIN-code on Antenna Reader 1, Relay 1 is automatically selected. If you enter the PIN-code on Antenna Reader 2, Relay 2 is automatically selected.
- Buttons 1 to 4 on the ImproX (QT) Quad Transmitter activate Relays 1 to 4 on the SupaGate Weatherproof Plus Controller. If only Buttons 1 and 2 are pressed during the “Add RF Tags” procedure then only those Buttons will activate the relevant Relays. Buttons 3 and 4 will have no action. Any combination is available. See Figure 1 for Button locations.



**Figure 1: Button Configuration for the ImproX (QT) Quad Transmitter Programmed in “Dynamic Code Transmission Mode”**

- The ImproX (QT) Quad Transmitter has its own passive Tag, separate from the transmitted codes. Presenting the ImproX (QT) Quad Transmitter passive Tag to Antenna Reader 1 drives Relay 1, likewise, presentation to Antenna Reader 2 drives Relay 2.

	Relay 1	Relay 2	Relay 3	Relay 4
Quad Transmitter	Button 1	Button 2	Button 3	Button 4
Passive Tag	Antenna Reader 1	Antenna Reader 2	-	-
4-Digit PIN-code	Antenna Reader 1	Antenna Reader 2	-	-
5-Digit PIN-code (Antenna Reader 1 or 2)	PIN XXXX1	PIN XXXX2	PIN XXXX3	PIN XXXX4
Request to Exit (RTE) Input	RTE Door 1	RTE Door 2	-	-

**Table 1: Relay Allocation Summary**

### Arc Suppression

Snubber devices are recommended for EMF Flyback and Arc Suppression when driving an inductive load with the Relay, see Figure 2.

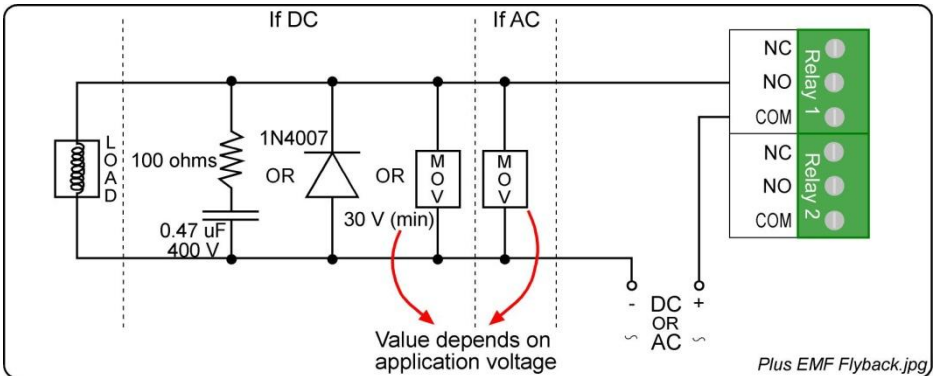

**Figure 2: EMF Flyback and Arc Suppression**

## MOUNTING THE SUPAGATE WEATHERPROOF PLUS

**CAUTION:** DO NOT mount the Controller on or close to a metal surface.

**CAUTION:** Ensure that you mount the Controller on a vibration-free surface.

**NOTE:** Test the SupaGate Weatherproof Plus, in the proposed installation location before mounting in position, ensuring the read range meets your needs.

For best performance, position the Controller for clear line-of-sight in the direction of the movement. The antenna should be in the vertical plane.

In Figure 3, a Tag moving along Motion 1 will be in line-of-sight of the antenna throughout the 10 m distance from first detection to the Controller. However, a Tag moving along Motion 02 will move out of line-of-sight of the antenna once it reaches Point A in Figure 3.

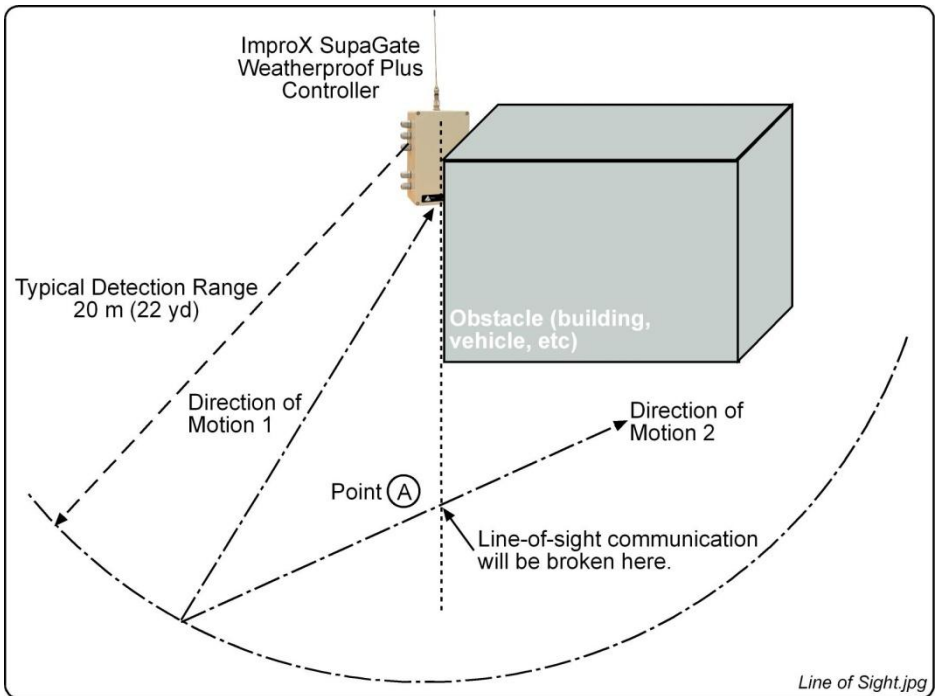

**Figure 3: Line of Sight**

1. After removing the SupaGate from its packaging, attach the Antenna.
2. Position the SupaGate in clear line-of-sight, preferably 1.50 m to 2 m (5 ft to 6 ft) above the ground, in the direction of movement, with the Antenna vertical.
3. Secure the Cabinet to the mounting surface, using four suitable screws and wall plugs (supplied), nuts and bolts or rivets.
4. The cabling for the Controller **MUST** pass through the Cable Glands provided. Once the Controller is installed and tested, seal the interior of the unused Cable Glands with general purpose Silicone Sealer.

Blank Space

# CONNECTING THE SUPAGATE WEATHERPROOF PLUS

Figure 4 shows the layout of the SupaGate Weatherproof Plus.

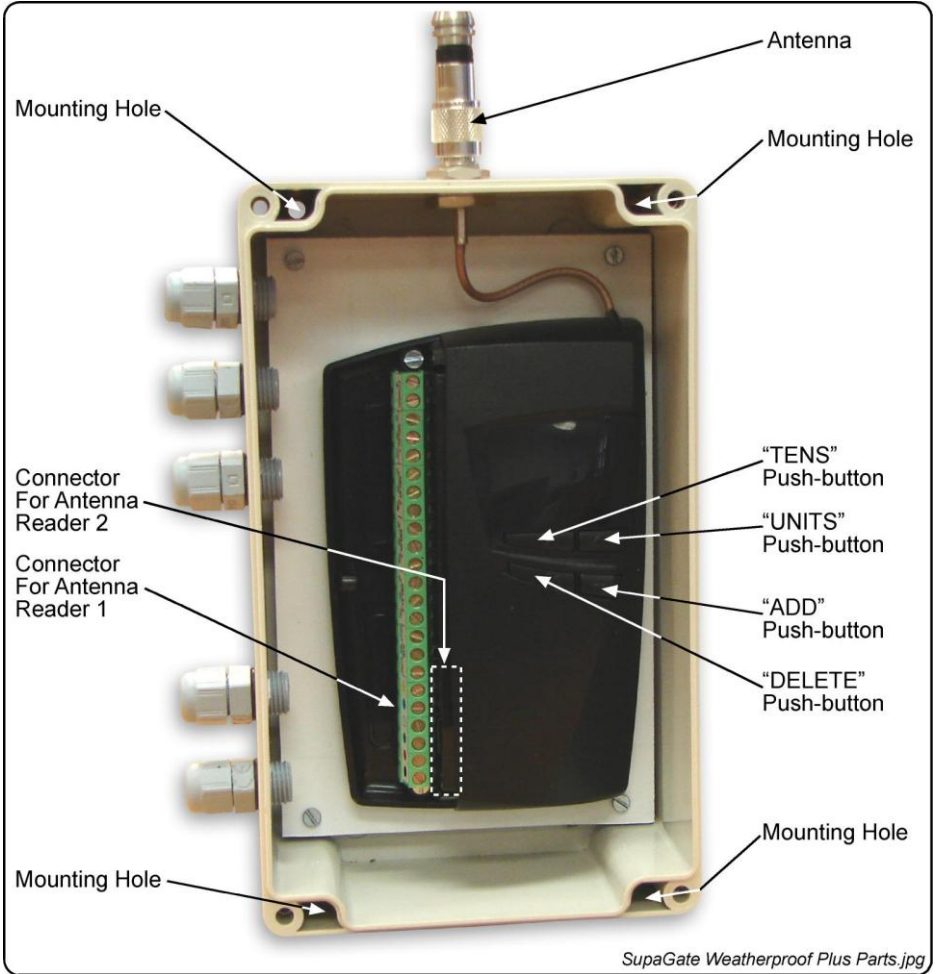

**Figure 4: SupaGate Weatherproof Plus Layout**

Blank Space

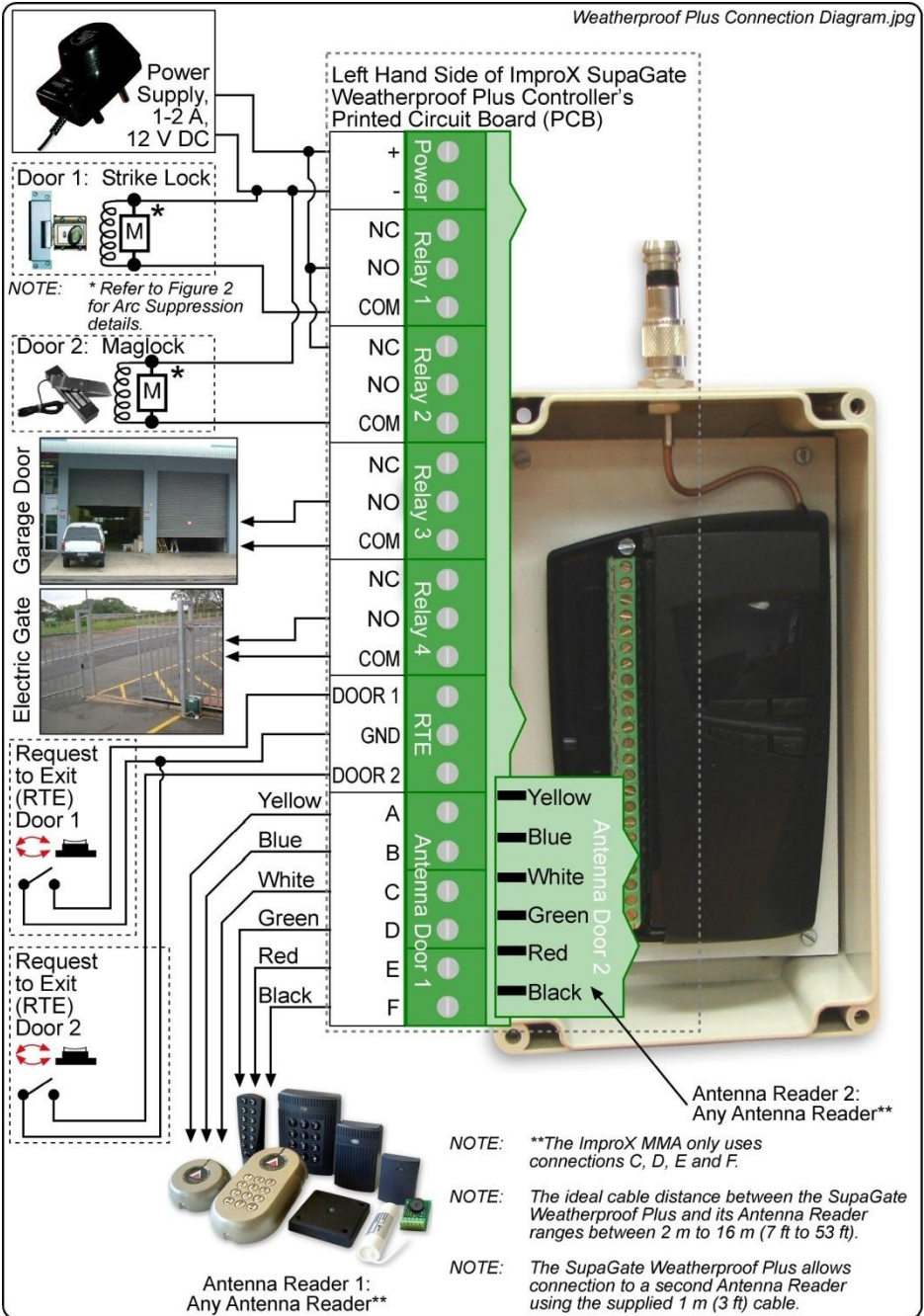



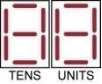
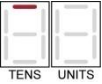
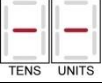
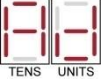
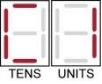
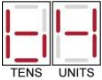
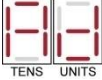
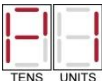

**Figure 5: Typical SupaGate Weatherproof Plus Electrical Connections**





# USER INFORMATION

Mode and Action	7-Segment Display LED	
	Displays	Duration
<b>POWER-UP</b>		2 seconds then enters Run Mode
<b>RUN MODE</b> Reading Tags		Rotates in a circular manner
<b>Unknown Tag</b>		2 seconds
<b>Tag Found</b>	Displays the Tag Memory Location (01-99)	2 seconds
<b>PROGRAMMING MODE</b> <b>Adding Passive Tags</b> 1. In Run Mode press the “ADD” Push-button for less than 1 second. 2. Press the “TENS” and “UNITS” Push-buttons until the desired Tag Location is shown. 3. Present the Passive Tag to the Antenna Reader. 4. Press “ADD” to return to Run Mode. <b>NOTES:</b> <ul style="list-style-type: none"> <li>Each new Tag Code received will display the Location at which it is being added.</li> <li>If the Tag already exists, it will be deleted and re-added in the same location.</li> <li>Ensure you present the Passive Tag to both Antenna Readers to gain access to both doors. If you enroll the Passive Tag only on Antenna Reader 1, access is only granted at Antenna Reader 1. Antenna Reader 2 does not give an allowed or denied signal. Antenna Reader 2 simply reports the Tag Location number on the SupaGate’s 7-segment display.</li> </ul>		1 second
	Displays the first free Location (01-99)	2 seconds
	Displays the Passive Tag (Card) number as follows:	
		



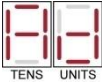

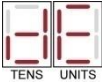
Mode and Action	7-Segment Display LED	
	Displays	Duration
<b>Adding RF Tags</b> 1. In Run Mode press the “ADD” Push-button for less than 1 second. 2. Press the “TENS” and “UNITS” Push-buttons until the desired Tag Location is shown. 3. Press only the Buttons on the ImproX (QT) Quad Transmitter that are required to be allowed. 4. Press “ADD” to return to Run Mode. <b>NOTES:</b> <ul style="list-style-type: none"> <li>Each new Tag Code received will display the Location at which it is being added.</li> <li>If the Tag already exists, it will be deleted and re-added in the same location.</li> </ul>		1 second
	Displays the first free Location (01-99)	2 seconds
	Displays the Button Number as follows:    	
<b>Adding Normal (4-Digit) PIN-codes</b> 1. In Run Mode press the “ADD” Push-button for less than 1 second. 2. Press the “TENS” and “UNITS” Push-buttons until the desired Tag Location is shown. 3. Enter your 4-digit PIN-code on the Keypad Antenna Reader, followed by the “#” Key on the Keypad Antenna Reader. 4. Press “ADD” to return to Run Mode. <b>NOTE:</b> Ensure you enter the complete 4-digit code, followed by the “#” Key to gain entry.		1 second
	Displays the first free Location (01-99)	2 seconds
	Displays the PIN-code as follows: 	

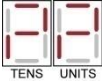
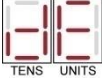
Blank Space

Mode and Action	7-Segment Display LED	
	Displays	Duration
<p><b>Adding Special (5-Digit) PIN-codes</b></p> <p>The PIN-code entered activates only the Relay specified as the 5<sup>th</sup> digit of the PIN-code.</p> <ol style="list-style-type: none"> <li>In Run Mode press the “ADD” Push-button for less than 1 second.</li> <li>Press the “TENS” and “UNITS” Push-buttons until the desired Tag Location is shown.</li> <li>Enter your 4-digit PIN-code on the Keypad Antenna Reader, followed by a single digit reference to the Relay you want to activate (See Table 1). Press the “#” Key on the Keypad Antenna Reader to complete the entry.</li> <li>Press “ADD” to return to Run Mode.</li> </ol> <p><i>NOTE: Ensure you enter the complete 5-digit code, followed by the “#” Key to gain entry.</i></p>		1 second
	<p>Displays the first free Location (01-99)</p>	2 seconds
	<p>Displays the PIN-code as follows:</p> 	
<p><b>Deleting Tags and PIN-codes</b></p> <ol style="list-style-type: none"> <li>In Run Mode press the “DELETE” Push-button.</li> <li>Press the “TENS” and “UNITS” Push-buttons until the desired Tag Location is shown.</li> <li>Press “DELETE” to delete the desired Location.</li> <li>Specify more Locations to be deleted, or press “DELETE” to return to Run Mode.</li> </ol>		1 second
		
		2 seconds
<p><b>Bulk Delete</b></p> <ol style="list-style-type: none"> <li>Power down the SupaGate Weatherproof Plus.</li> <li>Power up the SupaGate Weatherproof Plus while simultaneously pressing the “ADD” and “DELETE” Push-buttons.</li> <li>“??” is displayed, after 2 seconds all is deleted and “dE” is displayed.</li> </ol>		
		

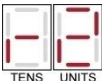
Blank Space

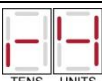
Mode and Action	7-Segment Display LED	
	Displays	Duration
<b>Replacing Lost Tags</b> 1. Delete the lost Tag from its Tag Location. (See the “Deleting Tags” section). 2. Add the new Tag to the abovementioned Tag Location. (See the “Adding Tags” section).	Displays the first free Location (01-99) <hr/> Displays selected Tag Memory Location	2 seconds
<b>Set Relay Durations</b> 1. In Run Mode press the “ADD” Push-button for longer than 1 second. 2. Press the “TENS” and “UNITS” Push-buttons to specify the duration of Relay 1 in seconds (00 = Toggled Mode).  <i>NOTE: The factory default setting is 01.</i>	 Displays the Relay Drive Time in seconds (01–99 seconds)	1 second
1. Press the “ADD” Push-button for less than 1 second. 2. Press the “TENS” and “UNITS” Push-buttons to specify the duration of Relay 2 in seconds (00 = Toggled Mode).  <i>NOTE: The factory default setting is 01.</i>	 Displays the Relay Drive Time in seconds (01–99 seconds)	1 second
1. Press the “ADD” Push-button for less than 1 second. 2. Press the “TENS” and “UNITS” Push-buttons to specify the duration of Relay 3 in seconds (00 = Toggled Mode).  <i>NOTE: The factory default setting is 01.</i>	 Displays the Relay Drive Time in seconds (01–99 seconds)	1 second
1. Press the “ADD” Push-button for less than 1 second. 2. Press the “TENS” and “UNITS” Push-buttons to specify the duration of Relay 4 in seconds (00 = Toggled Mode).  <i>NOTE: The factory default setting is 01.</i>	 Displays the Relay Drive Time in seconds (01–99 seconds)	1 second
3. Press “ADD” for less than 1 second to go back to Run Mode.		

Blank Space

## COMPLICATED CONCEPTS

- If a 5-digit PIN-code is registered on Antenna Reader 1, specifying Relay 2 as the Relay to be driven, then the 4-digit part of the PIN-code can be entered at Antenna Reader 2, driving Relay 2. No action results from the 4-digit PIN-code being entered on Antenna Reader 1.
- If the Tag + PIN-code function is required, then register a Tag at Antenna Reader 1 and a 5-digit PIN-code specifying Relay 2. Relays 1 and 2 can then be wired in series. Appropriate Relay durations need to be chosen.
- If the incorrect PIN-code is entered 3 times in succession, the Keypad locks for 20 seconds. During this period the RF System remains operational.
- If you select Button 1 on the ImproX (QT) Quad Transmitter to activate Relay 1, presenting the ImproX (QT) Quad Transmitters passive Tag to Antenna Reader 1 automatically activates Relay 1. This is because both the passive Tag and the RF Tag code on an ImproX (QT) Quad Transmitter have the same unique serial number. This only utilizes 1 of your 99 Locations.

Blank Space

## TAG LOCATIONS

Document all Tag owners at their respective Tag Memory Locations (in the SupaGate Weatherproof Plus) using Table 2. This list provides an easy reference when you need to delete Tags from the SupaGate Weatherproof Plus.

Owner		Relay or PIN-code					Owner		Relay or PIN-code				
		1	2	3	4	5/R			1	2	3	4	5/R
01							27						
02							28						
03							29						
04							30						
05							31						
06							32						
07							33						
08							34						
09							35						
10							36						
11							37						
12							38						
13							39						
14							40						
15							41						
16							42						
17							43						
18							44						
19							45						
20							46						
21							47						
22							48						
23							49						
24							50						
25							51						
26							52						

Owner		Relay or PIN-code					Owner		Relay or PIN-code				
		1	2	3	4	5/R			1	2	3	4	5/R
53							77						
54							78						
55							79						
56							80						
57							81						
58							82						
59							83						
60							84						
61							85						
62							86						
63							87						
64							88						
65							89						
66							90						
67							91						
68							92						
69							93						
70							94						
71							95						
72							96						
73							97						
74							98						
75							99						
76													

**Table 2: Tag Location Table**

Blank Space

## GUARANTEE OR WARRANTY

**CAUTION:** We reserve the right to nullify the products guarantee or warranty where you have not properly installed the Metal-oxide Varistors.

This product conforms to our Guarantee or Warranty details placed on our Web Site to read further please go to [www.impro.net](http://www.impro.net).

## USER NOTES



This manual is applicable to the ImproX SupaGate Weatherproof Plus 4-Channel Controller, SGI914-1-1-GB-00.

(The last two digits of the stock code indicate the issue status of the product).

SGI305-0-0-GB-03

Issue 04

Apr 2008

ImproX SupaGate Plus\English Manuals\LATEST  
ISSUE\XSGtWP+-inism-en-04.docx