

1.0 Megapixel Day/Night H.264 HD Pendant Dome Camera



Avigilon's end-to-end surveillance solutions deliver image detail no other system can match. Avigilon Control Center software, featuring High-Definition Stream Management™ (HDSM™) technology combined with our broad range of megapixel cameras (from 1 MP to 29 MP) provide unprecedented clarity—while effectively managing storage and bandwidth requirements. Our components are scalable and can work together in an end-to-end system, or can be customized to create your own powerful and cost-effective solution.

The innovative H.264 HD dome camera is just one way Avigilon can help provide the very best monitoring and protection.



The 1.0MP H.264 HD pendant dome camera provides coverage for both daytime and nighttime outdoor activities with peace of mind due to its vandal-resistant construction. It features an integrated lens for remote focus and zoom control and is ONVIF compliant for no-hassle integration with existing systems. The 1.0MP dome camera operates on Avigilon's H3 platform, providing this model with improved low light performance and enhanced HDSM features. P-Iris control also allows the camera to automatically set its iris position to maximize image quality in all lighting conditions. This camera is extremely versatile and can work in almost any location, including banks, schools, retail outlets, municipal grounds and buildings, hotels, bars and restaurants.

*Mount sold separately (MNT-PEND-WALL).

KEY FEATURES

- 1.0 megapixel progressive scan CMOS sensor
- Unsurpassed image quality
- Available with 3-9 mm F1.2 or 9-22 mm F1.6 P-Iris lens with remote focus and zoom
- 30 images per second at full resolution
- 69dB true dynamic range
- H.264 and Motion JPEG compression
- ONVIF compliant API
- Multiple video streams
- Automatic removable IR cut filter for IR sensitivity at night
- Power over Ethernet, 24 VAC or 12 VDC power input
- Audio Input and Output
- Analog Video Output
- External I/O
- Vandal resistant construction and IP66 compliant

Specifications

	1.0-H3-DP1	1.0-H3-DP2		
CAMERA	Image Sensor	1/2.7" progressive scan CMOS		
	Active Pixels	1280 (H) x 720 (V)		
	Imaging Area	5.9 mm (H) x 3.3 mm (V) (0.231" (H) x 0.129" (V))		
	Minimum Illumination	0.2 lux (F1.2) in color mode; 0.02 lux (F1.2) in monochrome mode	0.4 lux (F1.6) in color mode; 0.04 lux (F1.6) in monochrome mode	
	Dynamic Range	69 dB		
	Lens	3-9 mm, F1.2, P-Iris, remote focus and zoom	9-22 mm, F1.6, P-Iris, remote focus and zoom	
	Angle of View	35° - 98°	15° - 35°	
	Image Compression Method	H.264 (MPEG-4 Part 10/AVC), Motion JPEG		
	Image Rate	30 (all resolutions)		
	Streaming	Multi-stream H.264 and Motion JPEG		
	Resolution Scaling	Down to 768 x 432		
	Motion Detection	Selectable sensitivity and threshold		
	Electronic Shutter Control	Automatic, Manual (1/6 to 1/8000 sec)		
	Iris Control	Automatic, Manual		
	Day/Night Control	Automatic, Manual		
	Flicker Control	50 Hz, 60 Hz		
	White Balance	Automatic, Manual		
	Privacy Zones	Up to 4 zones		
	Audio Compression Method	G.711 PCM 8 kHz		
	Audio Input	Line input, A/V mini-jack (3.5 mm)		
	Audio Output	Line level, A/V mini-jack (3.5 mm)		
	Video Output	NTSC/PAL, A/V mini-jack (3.5 mm)		
	External I/O Terminals	Alarm In, Alarm Out		
NETWORK	Network	100BASE-TX		
	Cabling Type	CAT5		
	Connector	RJ-45		
	API	ONVIF compliant (www.onvif.org)		
	Security	Password protection, HTTPS encryption, digest authentication, WS authentication, user access log.		
	Protocol	IPv4, HTTP, HTTPS, SOAP, DNS, NTP, RTSP, RTP, TCP, UDP, IGMP, ICMP, DHCP, Zeroconf, ARP		
	Streaming Protocols	RTP/UDP, RTP/UDP multicast, RTP/RTSP/TCP, RTP/RTSP/HTTP/TCP, RTP/RTSP/HTTPS/TCP, HTTP		
MECHANICAL	Dimensions (ØxH)	167 mm x 157 mm (6.6" x 6.2")		
	Weight	2.1 kg (4.6 lbs)		
	Dome Bubble	Polycarbonate, clear		
	Body	Aluminum		
	Housing	Pendant mount, vandal resistant		
	Finish	Powder coat, cool gray 2		
	Adjustment Range	360° pan, 180° tilt, 180° azimuth		
ELECTRICAL	Power Consumption	10 W with external power 10 W with IEEE 802.3af Class 3 PoE		
	Power Source	VDC: 12 V +/- 10%, 10 W min VAC: 24 V +/- 10%, 12 VA min PoE: IEEE802.3af Class 3 compliant		
	Power Connector	2-pin terminal block		
ENVIRONMENTAL	Operating Temperature	-30°C to +50°C (-22°F to 122°F)		
	Storage Temperature	-10°C to +70°C (14°F to 158°F)		
CERTIFICATIONS	Safety	UL 60950 CSA 60950	EN 60950-1 CE	ROHS WEEE
	Environmental	IK10 Impact Rating Meets IP66 Weather Rating		
	Electromagnetic Emissions	FCC Part 15 Subpart B Class B	IC ICES-003 Class B	EN 55022 Class B
	Electromagnetic Immunity	EN 55024 EN 61000-4-2 EN 61000-4-3	EN 61000-4-4 EN 61000-4-5	EN 61000-4-6 EN 61000-4-11
ORDERING INFORMATION	1.0-H3-DP1	1.0 Megapixel Day/Night H.264 HD 3-9mm Pendant Dome Camera		
	1.0-H3-DP2	1.0 Megapixel Day/Night H.264 HD 9-22mm Pendant Dome Camera		
	H3-DOP-SMOKE	Dome Camera Cover with Smoked Bubble		
	MNT-PEND-WALL	Indoor/Outdoor Pendant Mount Bracket		

Outline Dimensions

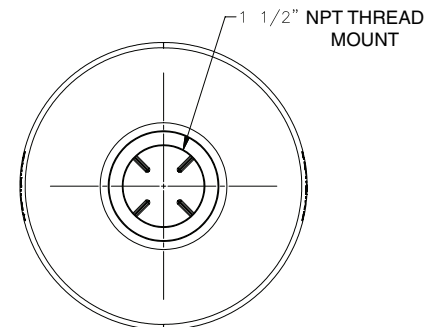
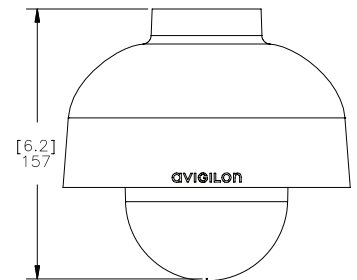
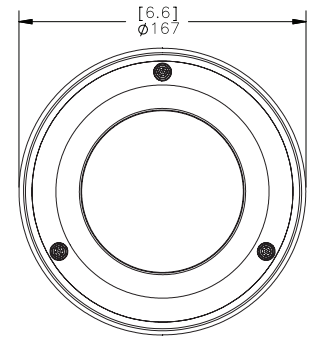

[X.X]	INCHES
X	MM