

AVerMedia[®]
AVerDiGi EB1504 MPEG4
Real-time Security DVR

Operation Manual



FC CE

FCC NOTICE (Class A)



This device complies with Part 15 of the FCC Rules. Operation is subject to the following two conditions: (1) this device may not cause harmful interference, and (2) this device must accept any interference received, including interference that may cause undesired operation.

Federal Communications Commission Statement

NOTE- This equipment has been tested and found to comply with the limits for a Class A digital device, pursuant to Part 15 of the FCC Rules. These limits are designed to provide reasonable protection against harmful interference when the equipment is operated in a commercial environment. This equipment generates, uses and can radiate radio frequency energy and, if not installed and used in accordance with the instructions, may cause harmful interference to radio communications. Operation of this equipment in a residential area is likely to cause harmful interference in which case the user will be required to correct the interference at his own expense.

CAUTION ON MODIFICATIONS

To comply with the limits for the Class A digital device, pursuant to Part 15 of the FCC Rules, this device must be installed in computer equipment certified to comply with the Class A limits. All cables used to connect the computer and peripherals must be shielded and grounded. Operation with non-certified computers or non-shielded cables may result in interference to radio or television reception.

Changes and modifications not expressly approved by the manufacturer could void the user's authority to operate this equipment.

European Community Compliance Statement (Class A)



This product is in conformity with the protection requirements of EU Council Directives 89/336/EEC amended by 92/31/EEC on the laws of the Member States relating to electromagnetic compatibility.

Warning - This is a Class A product. In a domestic environment this product may cause radio interference in which case the user may be required to take adequate measures to correct this interference.

DISCLAIMER

No warranty or representation, either expressed or implied, is made with respect to the contents of this documentation, its quality, performance, merchantability, or fitness for a particular purpose. Information presented in this documentation has been carefully checked for reliability; however, no responsibility is assumed for inaccuracies. The information contained in this documentation is subject to change without notice.

In no event will AVerMedia be liable for direct, indirect, special, incidental, or consequential damages arising out of the use or inability to use this product or documentation, even if advised of the possibility of such damages.

TRADEMARKS

AVerMedia is registered trademarks of AVerMedia TECHNOLOGIES, Inc. IBM PC is a registered trademark of International Business Machines Corporation. Macintosh is a registered trademark of Apple Computer, Inc. Microsoft is a registered trademark and Windows is a trademark of Microsoft Corporation. All other products or corporate names mentioned in this documentation are for identification and explanation purposes only, and may be trademarks or registered trademarks of their respective owners.

COPYRIGHT

© 2006 by AVerMedia TECHNOLOGIES, Inc. All rights reserved. No part of this publication may be reproduced, transmitted, transcribed, stored in a retrieval system, or translated into any language in any form by any means without the written permission of AVerMedia TECHNOLOGIES, Inc.



THE MARK OF CROSSED-OUT WHEELED BIN INDICATES THAT THIS PRODUCT MUST NOT BE DISPOSED OF WITH YOUR OTHER HOUSEHOLD WASTE. INSTEAD, YOU NEED TO DISPOSE OF THE WASTE EQUIPMENT BY HANDING IT OVER TO A DESIGNATED COLLECTION POINT FOR THE RECYCLING OF WASTE ELECTRICAL AND ELECTRONIC EQUIPMENT. FOR MORE INFORMATION ABOUT WHERE TO DROP OFF YOUR WASTE EQUIPMENT FOR RECYCLING, PLEASE CONTACT YOUR HOUSEHOLD WASTE DISPOSAL SERVICE OR THE SHOP WHERE YOU PURCHASED THE PRODUCT.

Battery Safety Information

- Store the batteries in a cool dry place.
- Do not dispose of used batteries in domestic waste. Dispose of batteries at special collection points or return to point of sale if applies.
- Remove the batteries during long periods of non-use. Always remove exhausted batteries from the remote control. Battery leakage and corrosion can damage this remote control, dispose of batteries safely.
- Do not mix old and new batteries.
- Do not mix different types of batteries: alkaline, standard (carbon-zinc) or rechargeable (nickel-cadmium).
- Do not dispose of batteries in a fire. The batteries may explode or leak.
- Never short circuit the battery terminals.



WARNING

TO REDUCE RISK OF FIRE OR ELECTRIC SHOCK, DO NOT EXPOSE THIS APPLIANCE TO RAIN OR MOISTURE.



CAUTION

IF THERE IS ANY DAMAGE, SHORTAGE OR INAPPROPRIATE ITEM IN THE PACKAGE, PLEASE CONTACT WITH YOUR LOCAL DEALER. WARRANTY VOID FOR ANY UNAUTHORIZED PRODUCT MODIFICATION.

Table of Contents

Chapter 1 Introduction	1
1.1 Package Content.....	2
1.2 Features and Specifications	2
1.3 Front & Side Panel.....	3
1.4 Back Panel.....	5
1.5 Setting Up the DVR Unit	5
1.5.1 Installing the Hard Disk.....	5
1.5.2 Connecting Devices.....	8
1.5.3 Connecting the Sensor/Relay device.....	9
Chapter 2 Operating the EB1504 MPEG4	10
2.1 Using the EB1504 MPEG4 for the First Time.....	10
2.2 Surveillance Screen	10
2.3 Playback the Video	11
2.3.1 To Playback Video	11
Chapter 3 OSD Navigation Tree	13
3.1 Menu Function	13
Chapter 4 Using the USB Player	19
4.1 Recommended system requirements.....	19
4.2 Installing the USB Playback Application.....	19
4.3 Running the USB Playback Application.....	20
4.3.1 To Cut and Save the Portion of the Recorded Video	21
Chapter 5 Backup and View Recorded Video File	22
5.1 Recommended system requirements.....	22
5.2 To Backup Recorded Video File.....	22
5.3 To View the Backup File	24
5.3.1 To Cut and Save the Recorded Video.....	25
Chapter 6 Image Verification	27
6.1 To Run the ImageVerification program	27
Chapter 7 Warranty Notice	28

Chapter 1 Introduction

AverDiGi EB1504 MPEG4 is a 4-channel stand-alone DVR unit that provides real-time monitoring and digital recording of surveillance video. Up to four video cameras and four sensor devices can be hooked up to this DVR unit. It also provides one audio input and output channel.

Surveillance, digital recording and playback are controlled through the front panel buttons. With the On-Screen-Display (OSD) menu, user can customize video recording setting, sensor and alarm settings, password protection, hard drive recycling, and more. Through USB connection, user can playback the video with the bundled software, segment the video to keep the wanted portion exclusive and save it in MPG/AVI format. At the same time, also capture still image and save it in BMP format or print it.

Surveillance video is recorded in high-quality MPEG4 format. Two recording modes are supported; **D1 Mode** can record video from each video camera in higher resolution (720 x 480 / 720 x 576) at 60/50 fps and **CIF Mode** can record video in lower resolution (360 x 240 / 360 x 288) and up to 120/100 fps (NTSC/PAL).

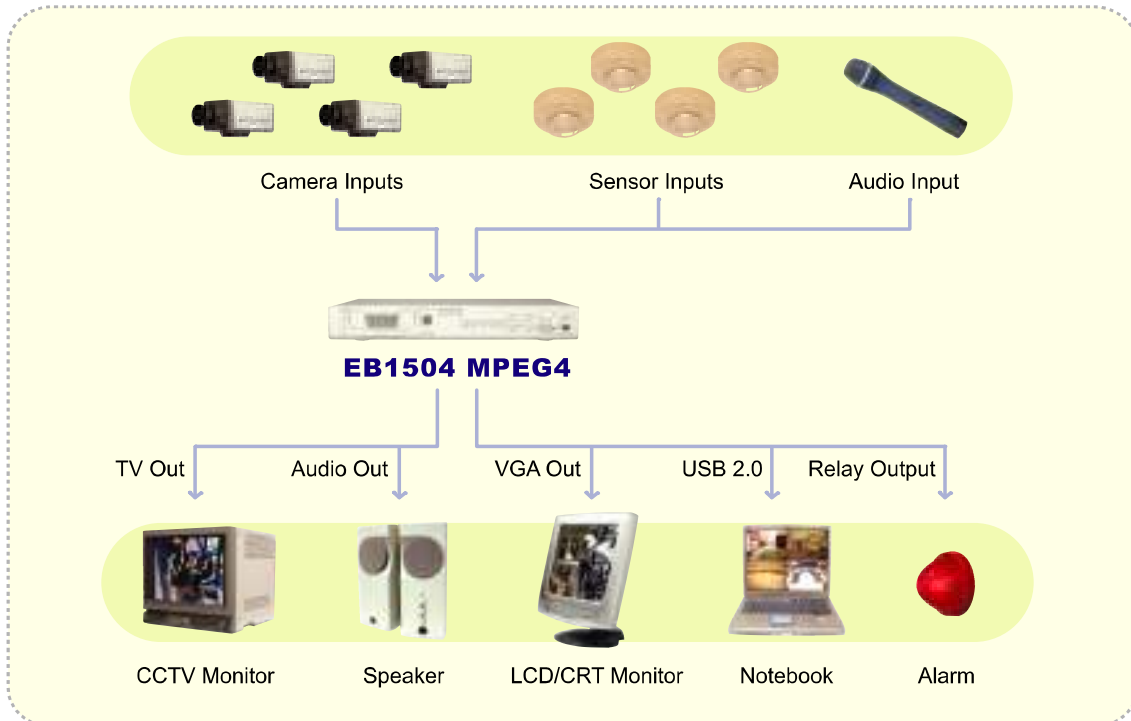

Connecting cameras, sensors, alarm, audio, and display device

1.1 Package Content

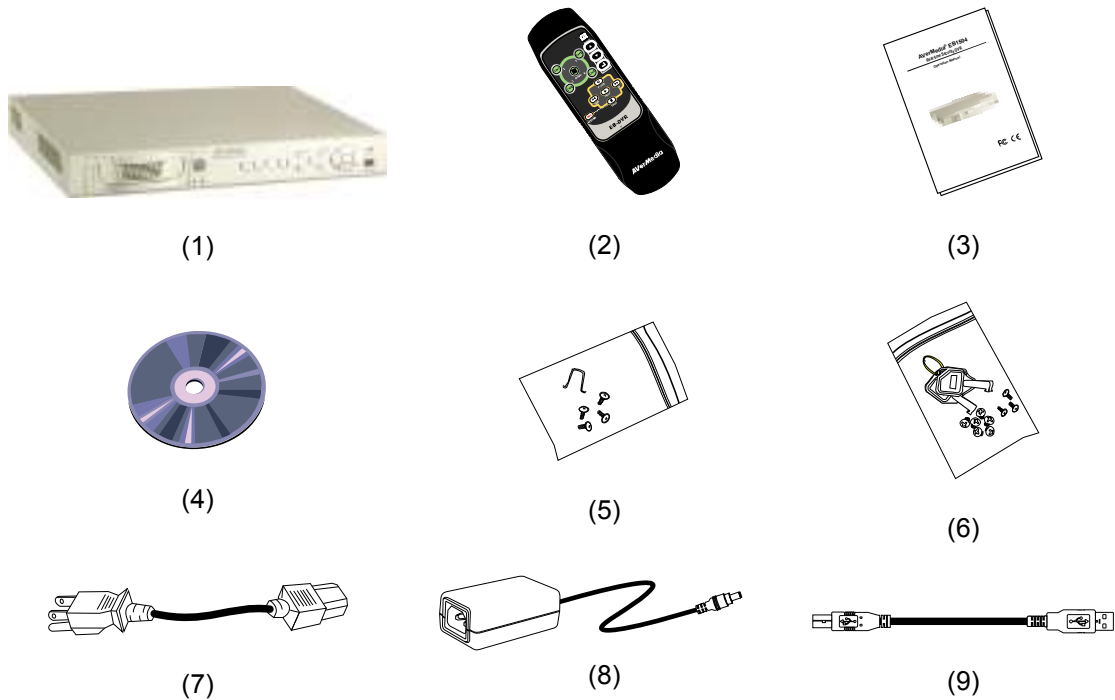

- (1) AVerMedia® AVerDiGi EB1504 MPEG4 unit
- (2) Remote Control (batteries included)
- (3) Quick Installation Guide
- (4) Software CD (User Manual included)
- (5) DVR accessories (including 4 screws and 1 Ω hook)
- (6) Removable hard disk drawer accessories (with spare screws)
- (7) Power Cord
 - * The power cord varies depending on the standard power outlet of the country where it is sold.
- (8) Power Adapter
- (9) USB Cable









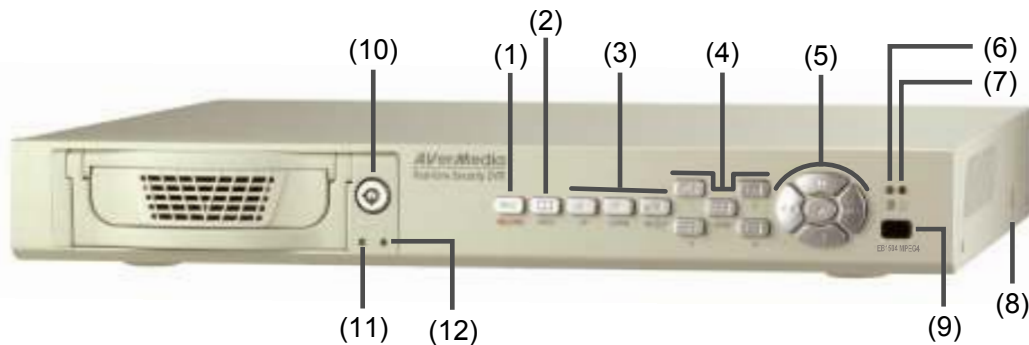



1.2 Features and Specifications











- Non-PC stand-alone security digital video recorder
- 4 composite video inputs and 1 composite output
- VGA output for LCD monitor display
- Front panel buttons and OSD control
- MPEG4 video compression

- Auto-detect NTSC or PAL video system
- Supports 2 hard drives (not included)
- Full-screen resolution:
 - Display:** 720 x 480 (NTSC), 720 x 576 (PAL)
 - Recording:** 720 x 480 (NTSC), 720 x 576 (PAL)
- Display frame rate:
 - Total of 120/100 fps (NTSC/PAL)
- Recording frame rate:
 - CIF mode:** Total 120/100 fps (NTSC/PAL)
 - D1 mode:** Total 60/50fps(NTSC/PAL)
- Scheduled recording (00:00~23:00 set by hour)
- Search for recorded videos by date/time/event
- Input/Output: 4 sensor inputs and 1 relay output control
- Removable hard disk bay
- One USB 2.0 Port
- Multiple language operation screens
- Software CD with USB playback application for Windows 2000/XP

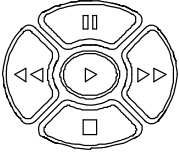
1.3 Front & Side Panel



Name	Function
(1) Record 	: Start video recording. To stop recording, press 
(2) Menu 	: Call up and exit the OSD main and sub menu
(3) UP/DOWN/SELECT   	: Use the UP and DOWN buttons to change setting and move to the left and right, and SELECT to enter or make a selection
(4) 1/2/3/4/Quad      	: Use these buttons in playback mode to switch to display each channel in full screen or view all channels at the same time Use the buttons in setting password of OSD menu to:  : For "1"

Name	Function
	 : For "2"  : For "3"  : For "4"  : For "0"
	 If in QUAD record mode, user would not be able to view single channel in full screen
(5) Playback/OSD Menu Control Buttons 	Use the buttons in playback mode to: ▶ : Display the play list and play the recorded video ◀◀ : Wind back the video playback at the speed of 2x, 4x, 8x or 16x ▶▶ : Fast play the video playback at the speed of 2x, 4x, 8x or 16x : Temporarily freeze the video playback ■ : Stop video playback Use the buttons in navigating OSD menu to: ◀▶ : Move to the left and right ■ : Change the setting ▶ : Make a selection
(6) HDD LED 	: Indicate running state of the hard disk. Lights when the HDD is running
(7) DVR Power LED 	: Lights when the unit is on
(8) USB 2.0 Port	: Connect to PC for video transfer or playback
	 Video recording must be STOPPED and press MENU , before making the connection. Make sure to connect it to USB 2.0 port
(9) IR Sensor	: Receive the signal from the remote control to operate the unit
(10) Removable HDD Keylock	: Lock/unlock the hard disk rack
	 Make sure to TURN OFF the unit BEFORE removing the hard disk
(11) Removable HDD LED 	: Indicate running state of the removable hard disk. Lights when the HDD is running
(12) Removable HDD Power LED 	: Indicate power of the removable hard disk. Lights when the HDD power is connected

1.4 Back Panel

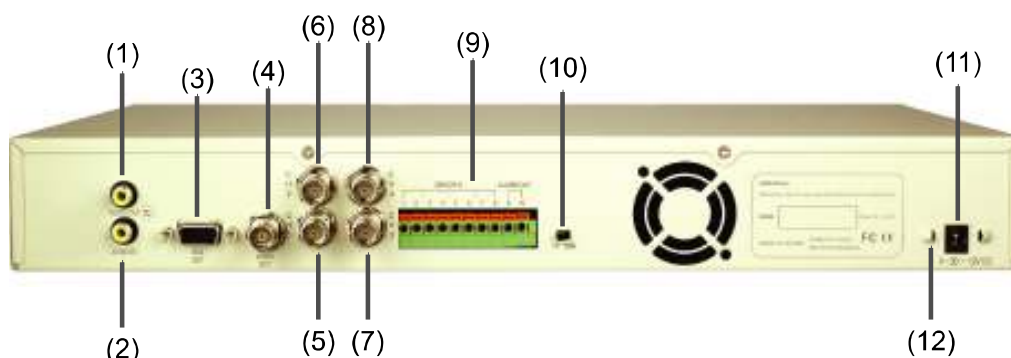

Name	Function
(1) Audio Out	: Output the audio signal to a speaker
(2) Audio In	: Input the audio signal from a mic or audio output device. The audio is embedded with channel 1
(3) VGA OUT	: Output the video signal to a CRT or LCD monitor
(4) Video Out (BNC)	: Output the video signal to a TV
 The DVR unit support 2 video output ports and you can only select to output the video either from the VGA OUT or VIDEO OUT	
(5) CH1	: Input the video camera signal and display it on channel 1
(6) CH2	: Input the video camera signal and display it on channel 2
(7) CH3	: Input the video camera signal and display it on channel 3
(8) CH4	: Input the video camera signal and display it on channel 4
(9) Sensor In & Alarm Out	: Support up to 4 sensor device and 1 relay device (Relay: 1A @ 125V AC/30V DC)
(10) TV-VGA	: Switch to select the video output. Make sure to set the video output before turning on the unit
(11) 12V DC	: Connect the power adapter into this port
(12) Ω Hook	: Fix the hook after connecting the power adapter

1.5 Setting Up the DVR Unit

1.5.1 Installing the Hard Disk

The DVR unit allows you to install up to two hard disks. Before installing the hard disk, make sure to set the hard disk master/slave jumper setting. Adjust the jumper setting according to the instructions on the hard disk label. Please set the jumper of hard disk as **Master** while there is only **one** hard disk inside the DVR.



- Use 40GB/ 7200RPM IDE hard disk or larger is recommended.
- Use hard disk of the same brand to avoid compatibility issue due to different hard disk models.

Follow the illustrated instructions below to install the hard disk:

1. Loosen all screws

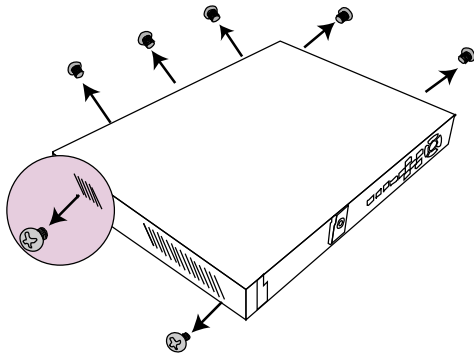

2. Push the cover backward and lift

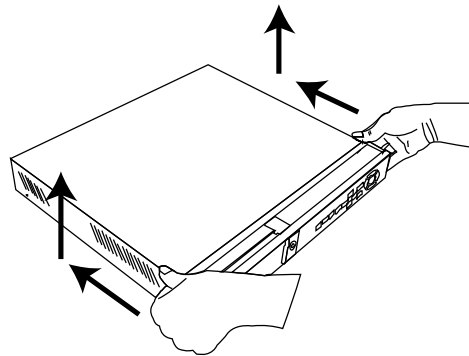

3. Loosen the hard disk rack 4 screws

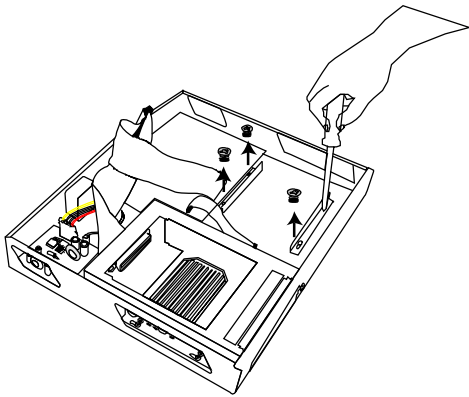

4. Secure the brackets on the hard disk (slave)

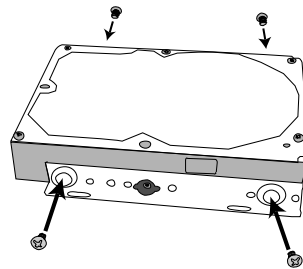

5. Connect the end of the IDE cable and the power connector to the hard disk (slave)

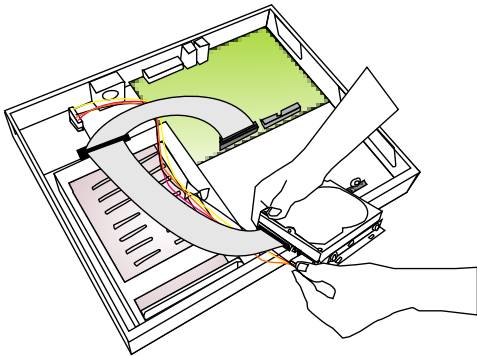

6. Secure the hard disk inside the unit then replace unit cover

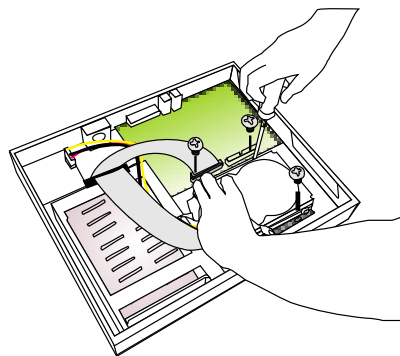

7. Unlock the removable hard disk drawer then pull it out

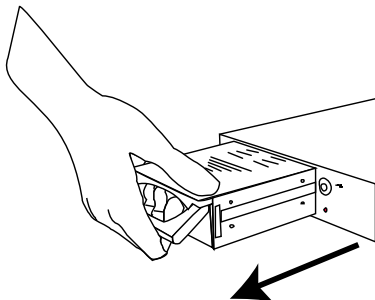

8. Remove the removable rack cover

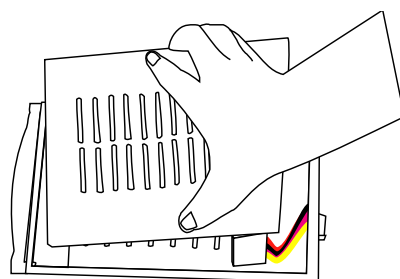

9. Connect the power connector to the hard disk (master)

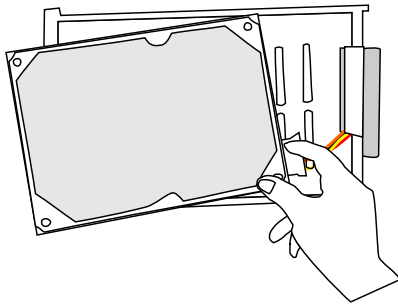

10. Carefully insert the hard disk in the removable rack then replace the removable rack cover

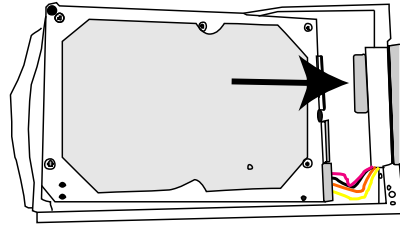

11. Slide the drawer back

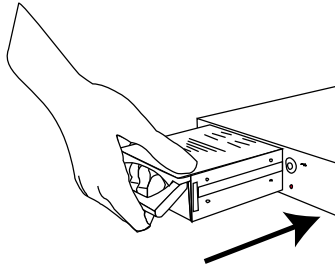

12. Lock the removable keylock

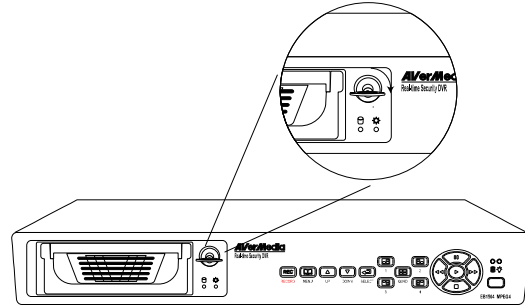

13. You may now connect all the cables. When the power is connected, the Power LED light  turns on



Before removing the removable hard disk drawer, the DVR Unit must be **TURNED OFF** and unlock the removable hard disk drawer keylock.

1.5.2 Connecting Devices

The back panel of the DVR unit, you can connect up to 4 video cameras, 4 sensor devices, 1 alarm device and output video to a TV or CRT/LCD monitor. Connecting the unit to a PC, through USB connection, the bundled software enables you to transfer, playback and segment the video.

Follow the illustration below to make the connection:

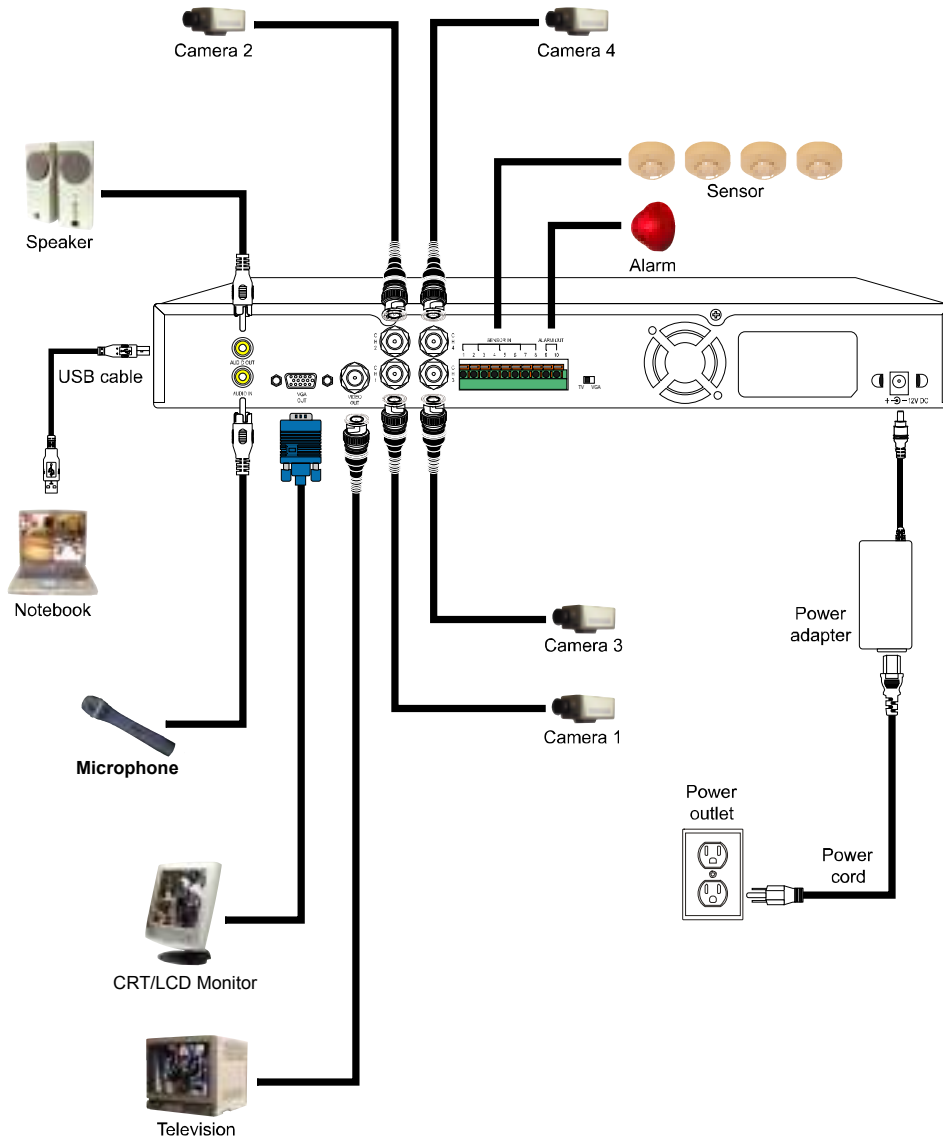

- The DVR unit supports 2 video output ports and you can only select **ONE** to output the video either from the VGA OUT or VIDEO OUT. The unit would not be able to display the video properly if you connect the device on both VGA OUT or VIDEO OUT at the same time.
- Each time you change the video display output, the power must be **UNPLUGGED** and **PLUGGED** to reset.

1.5.3 Connecting the Sensor/Relay device

The Sensor and Alarm ports enable you to connect (4) sensor inputs and (1) relay outputs. Just connect the external sensor and relay pin directly to the pinhole. Check the table below and locate which pinhole is assigned to sensor input and relay output.

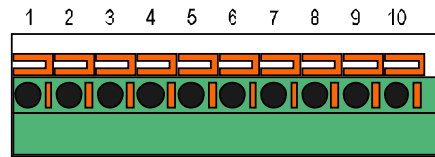



1.5.3.1 I/O Card Sensor and Relay pinhole allocation:

The signal from the sensor (i.e., infrared sensors, smoke detectors, proximity sensors, door sensors, etc.) is being transmitted to the unit and this triggers the system to respond and send signal to relay device (i.e., alarm, telephone etc).

Pin #	Definition
1	Sensor 1 input signal
2	Sensor 1 output signal
3	Sensor 2 input signal
4	Sensor 2 output signal
5	Sensor 3 input signal
6	Sensor 3 output signal
7	Sensor 4 input signal
8	Sensor 4 output signal
9	Relay ground connection
10	Relay Normal open output

Chapter 2 Operating the EB1504 MPEG4

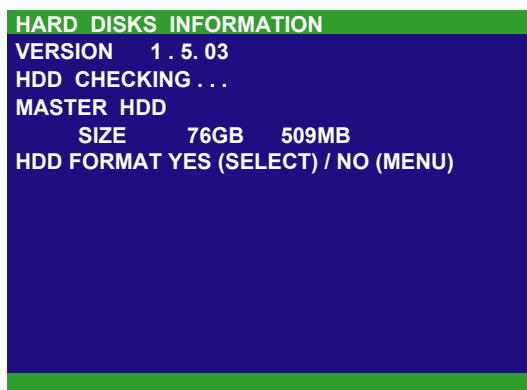

2.1 Using the EB1504 MPEG4 for the First Time

Upon connecting the power, the unit automatically detects the status of the hard disk. The hard disk must be formatted before you can use it with EB1504 MPEG4. If you are prompt to format the hard disk, press  (select) for **YES** to format the hard disk and  (menu) for **NO** to remain unchanged.



2.2 Surveillance Screen

User can switch to display each channel in full screen or 4 channels at the same time in D1 or CIF record mode.

To know if the channel is being recorded, the “●” record symbol would appear beside the channel number. The  (microphone) and  (speaker) indicate the availability of audio. The information below the screen shows the current date and time, recording mode (record schedule setting), hard disk drive (Master/Slave) and the percentage of the used hard disk space.

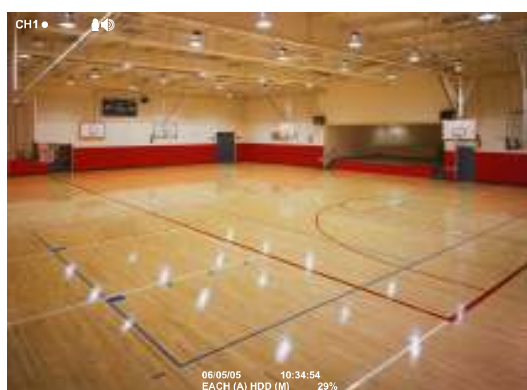

Full Screen Preview

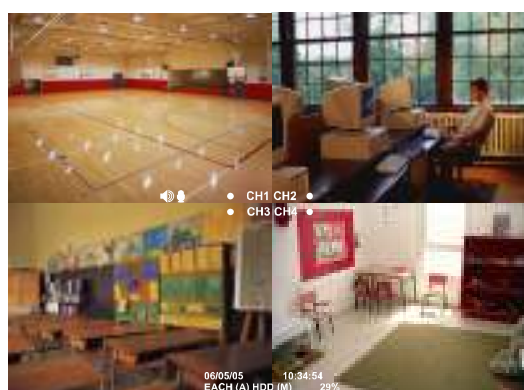

4-Channel Preview







When you are in full screen preview, press the following buttons on the remote control and control panel to switch to different channel, or preview all 4 channels:



2.3 Playback the Video







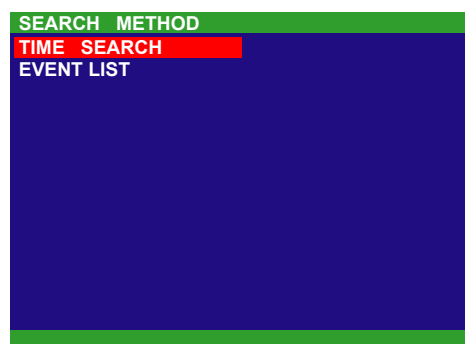

If the unit is recording the video, you may have to stop video recording in order to do video playback. To stop video recording, press .

2.3.1 To Playback Video









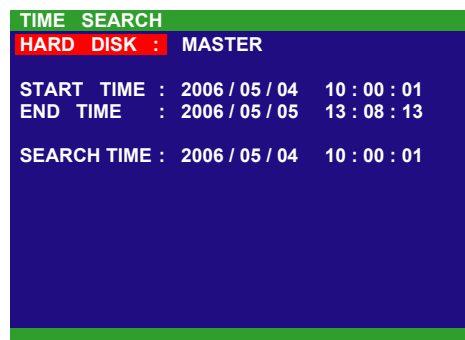















1. Press .
2. Use the  and  or  and  buttons to go up and down and select **TIME SEARCH** or **EVENT LIST**. Then, press  or  to make a selection.











TIME SEARCH (search by date and time):

1. In the selected **HARD DISK**, press  or . Then, use the  and  or  and  buttons to select **MASTER** or **SLAVE**. Press  or  again to make the selection. The **START TIME** and **END TIME** show the date and time from when the recording begins and end.







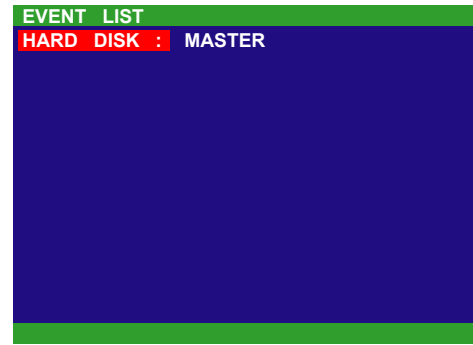

2. Use the  and  or  and  buttons and select **SEARCH TIME**. Then press  or  again to make the selection.
3. In the **SEARCH TIME**, you may now select the date and time from where you want to begin the video playback. Use the  and  or  and  buttons to move the selection to the left and right. Use the  and  or  and  buttons to select the date and time. Then press  or  again to make the selection.
4. To start video playback, the time in second must be set. Use the  or  buttons to move the selection to the left most. Use the  and  or  and  buttons and select the time in second. Then press  or .

EVENT LIST (search by condition):

1. In the selected HARD DISK, press  or . Then, use the  and  or  and  buttons to select **MASTER** or **SLAVE**. Press  or  again to make the selection.



2. Use the  and  or  and  buttons to select from the list. Press  or  again to make the selection.
3. Listed below are the following recording conditions:

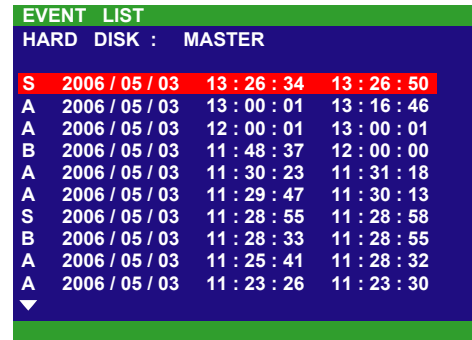

The screenshot shows a dark blue screen with a green header bar. The header bar contains the text "EVENT LIST" in white. Below the header, the text "HARD DISK : MASTER" is displayed in white on a red background. Below this, a list of recording conditions is shown in white text on a red background. The list includes columns for event type, date, and time.

Event Type	Date	Start Time	End Time
S	2006 / 05 / 03	13 : 26 : 34	13 : 26 : 50
A	2006 / 05 / 03	13 : 00 : 01	13 : 16 : 46
A	2006 / 05 / 03	12 : 00 : 01	13 : 00 : 01
B	2006 / 05 / 03	11 : 48 : 37	12 : 00 : 00
A	2006 / 05 / 03	11 : 30 : 23	11 : 31 : 18
A	2006 / 05 / 03	11 : 29 : 47	11 : 30 : 13
S	2006 / 05 / 03	11 : 28 : 55	11 : 28 : 58
B	2006 / 05 / 03	11 : 28 : 33	11 : 28 : 55
A	2006 / 05 / 03	11 : 25 : 41	11 : 28 : 32
A	2006 / 05 / 03	11 : 23 : 26	11 : 23 : 30

A – Always Recording

It records non-stop and automatically continue recording when interrupted.

S – Sensor Recording

It records when the sensor has activated.

B – Button Recording

It records when the  record button is pressed.

4. The “▶” play symbol would appear beside the channel number when you are previewing in playback mode.

Chapter 3 OSD Navigation Tree

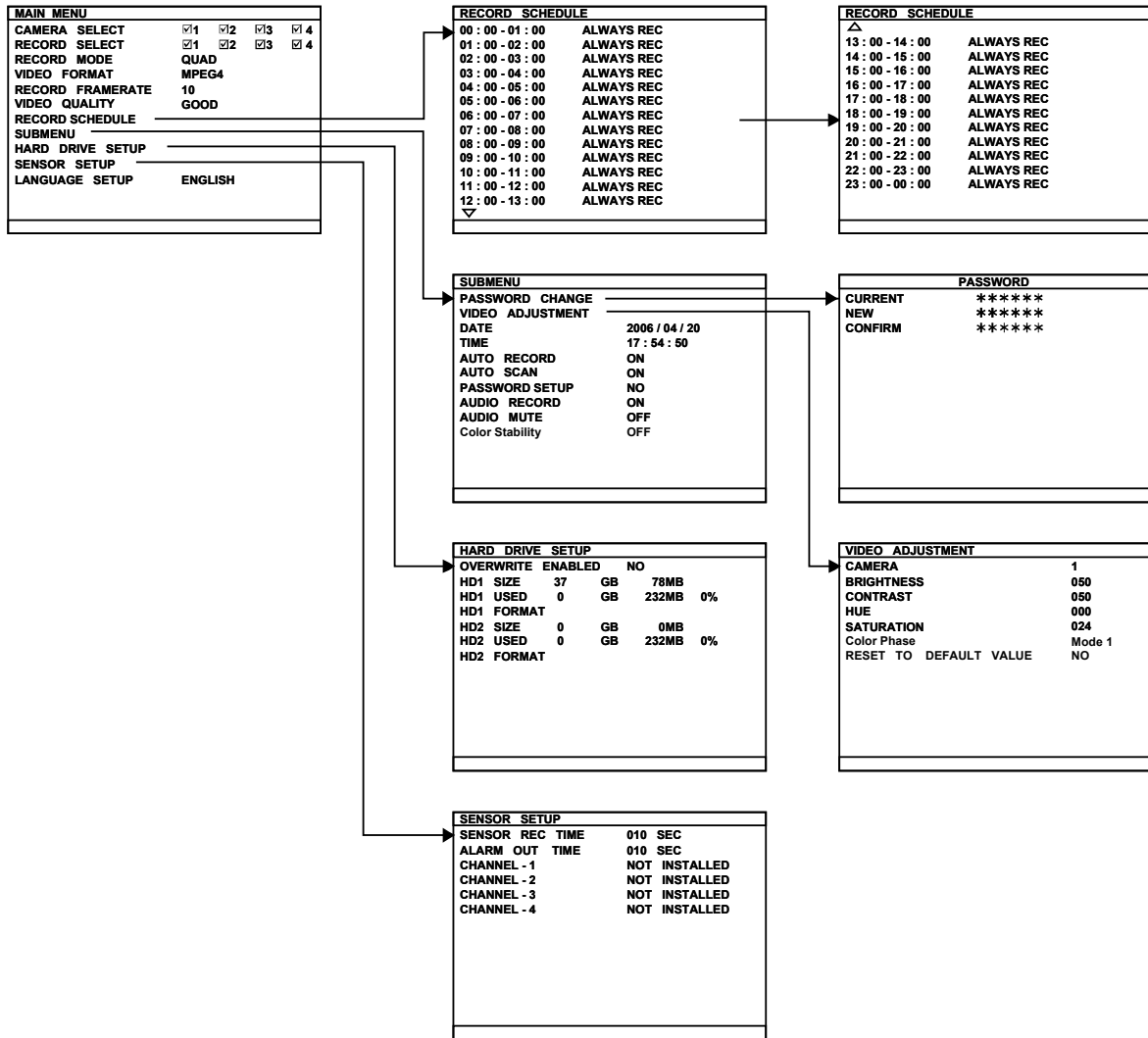





3.1 Menu Function

If the unit is currently recording the video, you may have to stop video recording to change the settings. To navigate in the OSD menu, press to call up and exit from the main menu or sub-menu display. Then use the and or and buttons to go up and down and select the items in the menu list or change the settings. Use the or button to enter sub-menu or make a selection. You can also use the and or and buttons to move the selection to the left and right. The red frame turns yellow when you are making a selection.

OSD MENU	Description									
MAIN MENU CAMERA SELECT <input checked="" type="checkbox"/> 1 <input checked="" type="checkbox"/> 2 <input checked="" type="checkbox"/> 3 <input checked="" type="checkbox"/> 4 RECORD SELECT <input checked="" type="checkbox"/> 1 <input checked="" type="checkbox"/> 2 <input checked="" type="checkbox"/> 3 <input checked="" type="checkbox"/> 4 RECORD MODE QUAD VIDEO FORMAT MPEG4 RECORD FRAMERATE 10 VIDEO QUALITY GOOD RECORD SCHEDULE SUBMENU HARD DRIVE SETUP SENSOR SETUP MOTION SETUP LANGUAGE SETUP ENGLISH	<p>CAMERA SELECT : Enable/disable the channel number to display the video on the surveillance screen.</p> <p>RECORD SELECT : Enable/disable the channel number to record video.</p> <hr/> <p> The channels that are enabled in the camera select setting can only be set for video recording.</p> <hr/> <p>RECORD MODE : Select D1/CIF recording mode. Under D1 mode, the video recording is in 720x480 or 720x576 resolution and takes turns from one channel to the next one. D1 channel is recorded at a maximum frame rate of 15fps/12fps (NTSC/PAL) for each channel. User can switch to view the video in single full screen or QUAD screen. Whereas in CIF mode, video recording is at a 360x240 or 360x288 resolution, but each video is recorded in 30fps/25fps (NTSC/PAL). User can also view the video in single full screen or QUAD screen.</p> <p>VIDEO FORMAT : The recorded video is in MPEG4 format.</p> <p>RECORD FRAME RATE : Set the number of frames per second to be recorded. Refer to the table below for the available record frame rate settings. The higher the frame rate, it uses more hard disk space.</p> <table border="1"> <thead> <tr> <th>Video Standard \ Record Mode</th> <th>NTSC</th> <th>PAL</th> </tr> </thead> <tbody> <tr> <td>EACH</td> <td>15, 5, 1</td> <td>12, 5, 1</td> </tr> <tr> <td>QUAD</td> <td>30, 15, 10, 5, 1</td> <td>25, 12, 5, 1</td> </tr> </tbody> </table> <p>VIDEO QUALITY : Select the video quality setting from BEST, GOOD or NORMAL. Choosing NORMAL allows you to record more hours but the quality of the recorded video is moderate. For more information about the recording time, please visit our website and look for EB1504 MPEG4.</p> <p>LANGUAGE SETUP : Select from the available language.</p>	Video Standard \ Record Mode	NTSC	PAL	EACH	15, 5, 1	12, 5, 1	QUAD	30, 15, 10, 5, 1	25, 12, 5, 1
Video Standard \ Record Mode	NTSC	PAL								
EACH	15, 5, 1	12, 5, 1								
QUAD	30, 15, 10, 5, 1	25, 12, 5, 1								

OSD MENU	Description								
	<p>RECORD SCHEDULE:</p> <p>By default, in 24 hours, the recording schedule is set to always record every hour. Refer to the table below to customize the recoding condition.</p> <table border="1"> <thead> <tr> <th>Condition</th> <th>Description</th> </tr> </thead> <tbody> <tr> <td>NO REC</td> <td>Disable video recording.</td> </tr> <tr> <td>ALWAYS REC</td> <td>Record non-stop.</td> </tr> <tr> <td>SENSOR REC</td> <td>Start recording when the sensor has activated.</td> </tr> </tbody> </table>	Condition	Description	NO REC	Disable video recording.	ALWAYS REC	Record non-stop.	SENSOR REC	Start recording when the sensor has activated.
Condition	Description								
NO REC	Disable video recording.								
ALWAYS REC	Record non-stop.								
SENSOR REC	Start recording when the sensor has activated.								

OSD MENU	Description
	<p>PASSWORD CHANGE :</p> <p>Set a security combination number. This is a security measure that prevents formatting of the hard disk or changing the system settings. The factory default password is 111111. User could use , , , , and  to set each digit of password.</p>

VIDEO ADJUSTMENT :

Select the camera number and set to adjust the video brightness, contrast, hue, and saturation value.

DATE :

Set the current date.

 Please set the correct date and time when you use this DVR at the first time to make sure the time of recorded video file is correct.

TIME :

Set the current time.

AUTO RECORD :

Enable/disable auto continue recording when interrupted (i.e., power breakdown, video playback or configuration setup). It continue recording after 10 second of idleness. This is applicable in Always Record mode.

AUTO SCAN :

Enable/disable auto cycle switch to display the next channel when in full screen preview.

PASSWORD SETUP :

Enable/disable full system password protection. This would prevent unauthorized user to stop video recording, change system settings and formatting the hard disk.

AUDIO RECORD :

Enable/disable audio recording. To record sound, make sure the mic is connected to the unit.

AUDIO MUTE :

Enable/disable to hear audio sound. To hear sound, make sure the unit is connected to a speaker.



If you want to hear the voice when you playback the recorded file on this DVR, please make sure that you have selected Audio Mute Off.



















OSD MENU	Description
----------	-------------

HARD DRIVE SETUP				
OVERWRITE		ENABLED	YES	
HD1	SIZE	37	GB	78MB
HD1	USED	0	GB	232MB 0%
HD1	FORMAT			
HD2	SIZE	0	GB	0MB
HD2	USED	0	GB	232MB 0%
HD2	FORMAT			

* HD1//HD2 SIZE shows the total capacity of the hard disk.
 * HD1//HD2 USED shows the amount of space that has been used.

OVERWRITE ENABLED :
 Enable/disable replacing the earliest record when the hard disk space runs out. By default, the HDD overwrite setting is enabled.



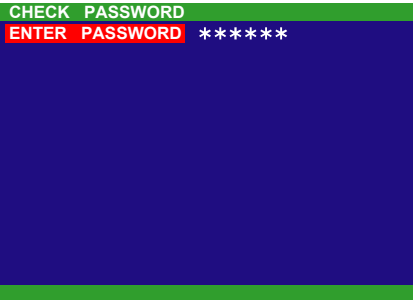

HD1 FORMAT / HD2 FORMAT :
 For security purpose, you may have to enter the password to format hard disk.

- To format hard disk:
1. Use the  and  or  and  buttons to go up and down and select **HD1 FORMAT**. Then press  or .
 2. In the CHECK PASSWORD screen, press  or . Then use the  and  or  and  buttons to select the security combination number. Press  or  button again to make the selection. Repeat till you key in the last number.
 To move the selection to the left and right, use  and  or  and  buttons.

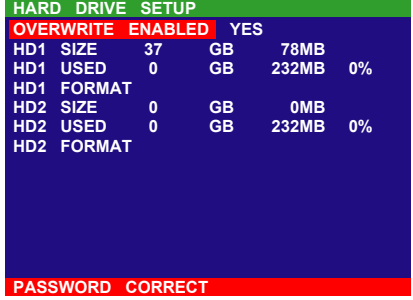

3. After entering the last number, if the **PASSWORD CORRECT** appears, you are now authorized to format the hard disk.



4. Use the  and  or  and  buttons and select the hard disk you want to format.
5. It is done when the **“HDD FORMAT COMPLETED”** appears.

 Formatting the hard disk will permanently delete all the records. The records can no longer be retrieved.

OSD MENU**Description**

```

SENSOR SETUP
SENSOR REC TIME 010 SEC
ALARM OUT TIME 010 SEC
CHANNEL - 1 NOT INSTALLED
CHANNEL - 2 NOT INSTALLED
CHANNEL - 3 NOT INSTALLED
CHANNEL - 4 NOT INSTALLED

```

SENSOR REC TIME :

Set the amount of time (in second) to record when the sensor has been triggered.

ALARM OUT TIME :

Set the amount of time (in second) to continue sending the alarm once activated.

CHANNEL 1~4 :

Customize the initial state of the attached sensor. Refer to the table below to customize the sensor state.

Condition	Description
NOT INSTALLED	Indicates that there is no sensor connected.
NORMAL OPEN	Indicates that the initial state of the sensor is normal open. Video recording initiate when there is a change in the sensor state.
NORMAL CLOSE	Indicates that the initial state of the sensor is normal close. Video recording initiate when there is a change in the sensor state.

Chapter 4 Using the USB Player

4.1 Recommended system requirements

- Pentium®4 2.4GHZ or above
- Windows®2000/ XP
- DDR 256 MB
- Graphic function must support DirectDraw
- Audio card or built-in
- Speaker
- 1 available USB2.0 port

4.2 Installing the USB Playback Application

To install the USB Playback Application:

1. Place Installation CD into the CD-ROM drive. When the installation main screen appears, click **Install USB Playback Application** and then follow the on screen instructions



2. Select the language you prefer



3. Click **OK** to install the application
4. Click **“Exit”** to close the installation main screen. You may now connect the USB cable

4.3 Running the USB Playback Application

To run the application, click the USB Player icon

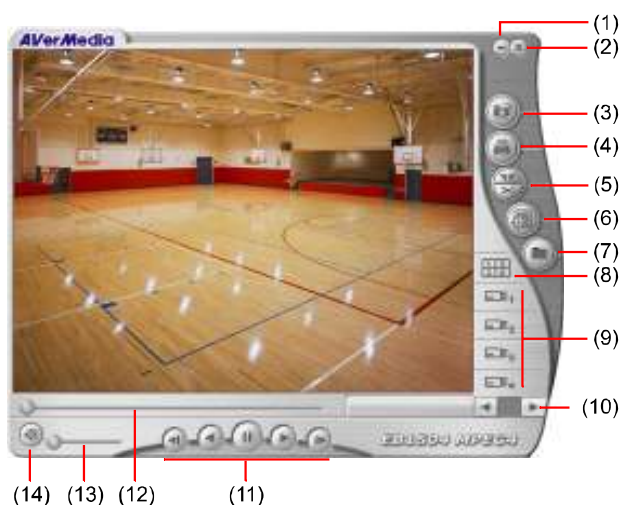

Name	Function
(1) Minimize	Reduce the application to a button on the taskbar
(2) Exit	Close the application
(3) Snapshot	Capture and save the image either in *.jpg or *.bmp format
(4) Print	Print the image
(5) Segment/ Output	Keep a portion of the video and save it in *.mpg or *.avi format (see also Chapter 4.3.1)

Select the event you want to playback

(6) Event List

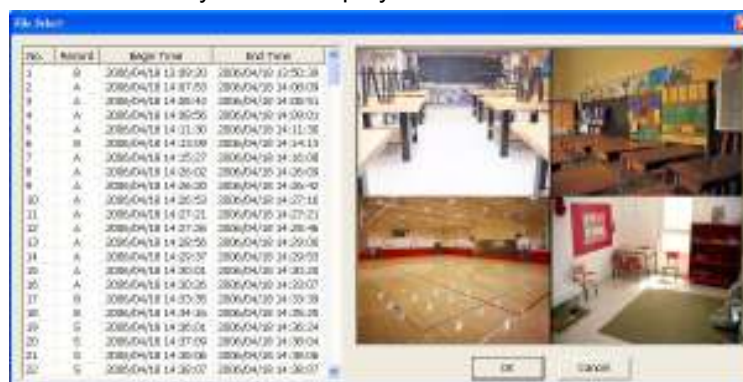

Select the hard disk drives

(7) HD List

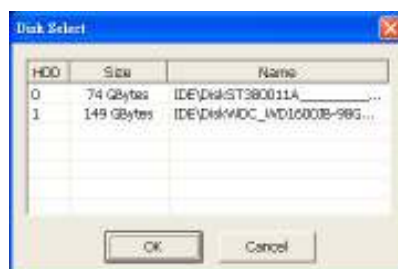

(8) Quad	Display all 4 channels in one screen
(9) Channel number	Switch and display one channel

Name	Function
(10) Speed up/down	Adjust speed of video playback
(11) Playback Controller	Backward one frame: Go back one frame Backward Play: Play the video file in reverse Pause: Briefly stop playing the video file Play: Start/continue playing the video file Forward one frame: advance one frame
(12) Progress bar	Show the progress of the file being played. You may move the bar to seek at any location of the track
(13) Sound bar	Adjust the volume
(14) Sound	Turn on and off the sound

4.3.1 To Cut and Save the Portion of the Recorded Video

1. Use the Playback Control buttons or drag the bar on the playback progress bar and pause on where you want to start the cut. Then, click Segment to set the begin mark.



2. Use the Playback Control buttons or drag the bar on the playback progress bar and pause on where you want to end the cut. Then, click Segment to set the end mark. To cancel segmentation, click Segment button again.



3. Click Output button to save the wanted portion.
4. In the Save As dialog box, locate on where user want to save the file, type the filename, and select the video format.

Chapter 5 Backup and View Recorded Video File

5.1 Recommended system requirements

- Pentium®4 2.4GHZ or above
- Windows®2000/ XP
- DDR 256 MB
- Graphic function must support DirectDraw
- Audio card or built-in
- Speaker
- 1 available USB2.0 port

5.2 To Backup Recorded Video File

1. Connect PC with EB 1504 MPEG 4 through the USB cable
2. Place Installation CD into the CD-ROM drive. When the installation main screen appears, click **HDD Backup**.
3. OSD setup menu will appear on the surveillance monitor. Press **Select (Yes)** to accept HDD Backup application to get the recorded video file from the hard disk. And, EB1504 MPEG4 will stop recording automatically.
4. And then, the **Select Disk** windows will appear as below:

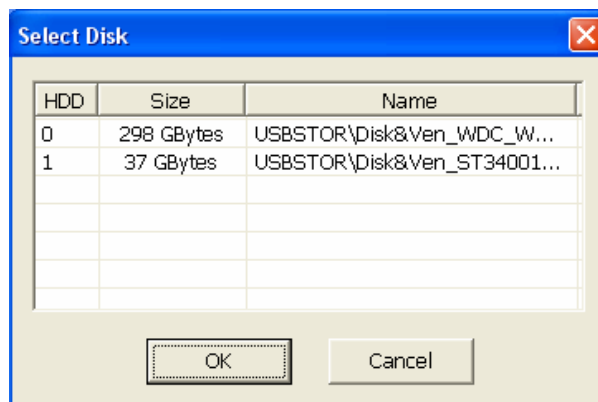

5. Select the hard disk drive from **Select Disk** windows. All available hard disk will list on the **Select Disk** windows with size and name
6. Select the hard disk drive and click **OK**
7. And then, the HDD Backup windows will appear as below:

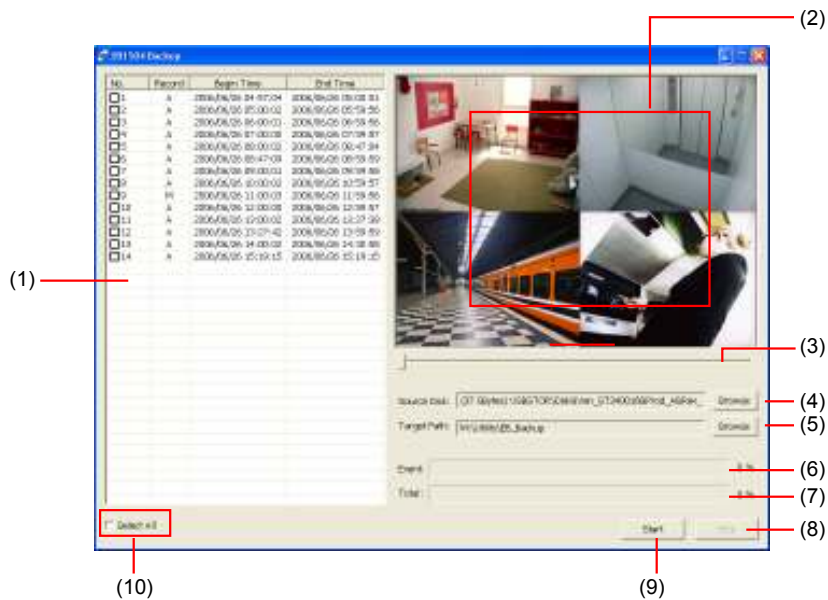

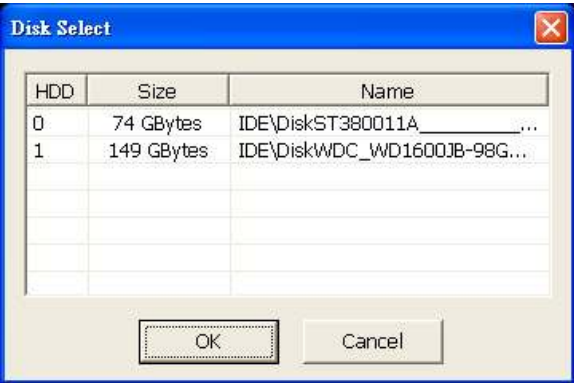
Name	Function
(1)	All recorded video events list No.: the list order number Record: the record type(see also Chapter 2.3.1) Begin Time: the beginning of record time End Time: the end of record time
(2)	Display first frame of each recorded channel video which user had selected. Total is 4 Channels
(3) Progress bar	Show the progress of the event being played. User may move the bar to seek at any location of the track
(4) Source Disk	To select the hard disk drive
	
(5) Target Path	To locate on where user want to save the file
(6) Event (%)	Display the backup progress rate of event in percentage
(7) Total (%)	Display the total backup progress rate in percentage
(8) Stop	Stop backup progress
(9) Start	Start backup progress
(10) Select All	Select all listed recorded video events

8. Select the event which user wants to backup. Or mark the **Select All** to select all listed recorded video event
9. Locate on where user want to save the backup file
10. Click **Start** to process backup
11. To stop the backup progress, click **Stop**



5.3 To View the Backup File





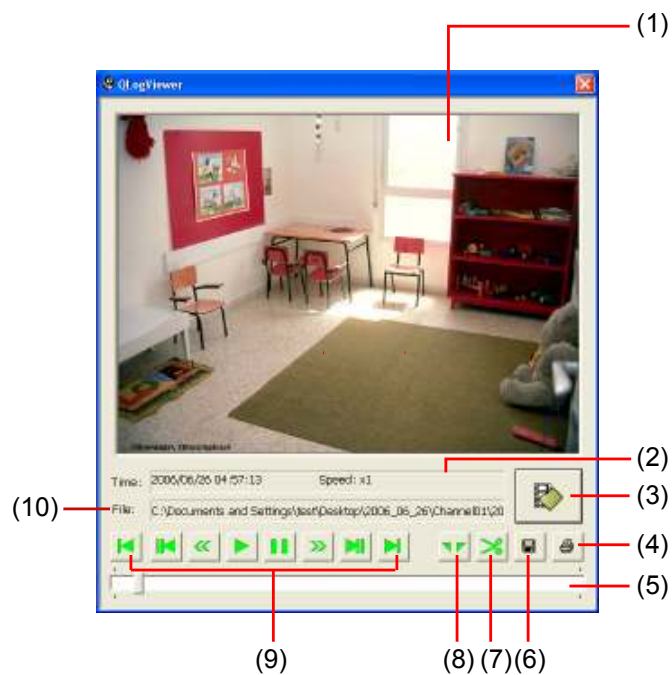





QLog Viewer is used to view the backup file of recorded video.

To view the backup files follow the below steps:

1. Place Installation CD into the CD-ROM drive. When the installation main screen appears, click **Qlog Viewer**.
2. And then, the QLog Viewer windows appear as below:



Name	Function
(1)	Display screen
(2) Time	Time of the playing file
(3) 	To select the backup file for playing
(4) 	Print the screen shot



Name	Function
(5) Progress bar	Show the progress of the file being played. User may move the bar to seek at any location of the track
(6) 	Save the screen shot
(7) 	Save a portion of the video in *.mpg or *.avi format
(8) 	Select a portion of the video and it will repeat playing(see also Chapter 5.3.1)
(9) Playback controller	 : Go to the beginning of the video  : Go back one frame  : Wind back the video playback at the speed of 1/2x, 1/4x or 1/8x  : Start/continue playing the video file  : Briefly stop playing the video file  : Fast play the video playback at the speed of 2x, 4x or 8x  : Advance one frame  : Go to the end of the video
(10) File	Path of the playing file

- Click  button and select the file that user wants to view. The backup file will be saved by the date of video recorded. And, in each backup file folder contents 4 channels' backup files
- Use Playback control to do the playback control



5.3.1 To Cut and Save the Recorded Video

- Use the Playback control buttons or drag the bar on the playback progress bar and pause on where user wants to start the cut. Then, click  to set the begin mark



- Use the Playback control buttons or drag the bar on the playback progress bar and pause on where user wants to end the cut. Then, click  to set the end mark. To cancel segmentation, click  button again



3. The marked portion will repeat to playback until press  button
4. Click  button to save the portion
5. In the **Save As** dialog box, locate on where user wants to save the file, type the filename, and select the video format

Chapter 6 ImageVerification

Image Verification is a watermark-checking program to identify the authenticity of a saved image (e.g. by snapshot). This program can only verify uncompressed bmp image files.

6.1 To Run the ImageVerification

1. Place Installation CD into the CD-ROM drive.
2. Browse the CD-ROM and look for **Utility** → **ImageVerification**. And then, double click to extract the program.
3. Click  to run ImageVerification application.
4. In the ImageVerification screen, click **Load Source Image** and locate the image source.
5. Click **Verify Image** to begin the process.
6. Check the result in the **Processed Image** screen. If the picture is unmodified, the image in the **Source Image** and **Processed Image** screen would be exactly the same. If the picture is being modified, a warning dialog box would prompt you and the modified area is highlighted.

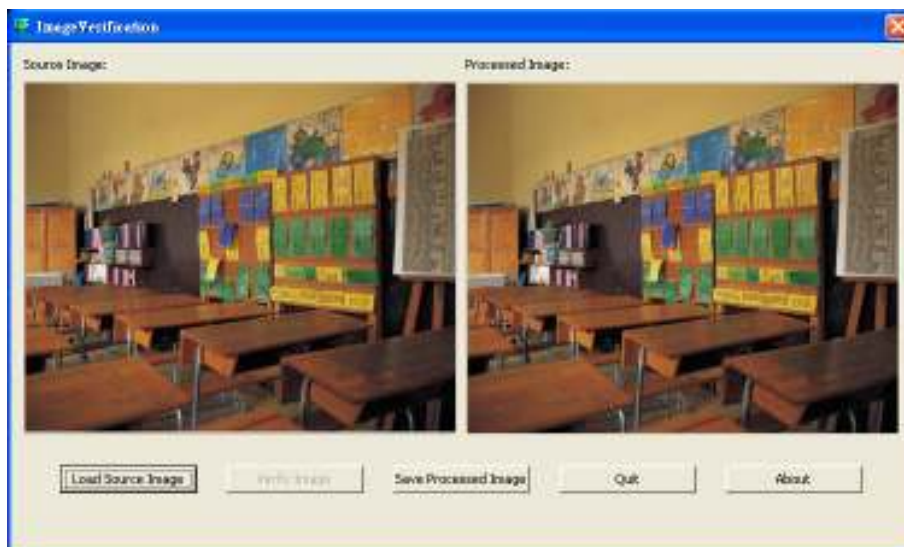

Chapter 7 Warranty Notice

LIMITED WARRANTY

AVerMedia TECHNOLOGIES, Inc. warrants this product to be free of defects resulting from faulty manufacture or components under the following terms:

WARRANTY LENGTH

Labor is warranted for (1) one year from the date of purchase.

Parts are warranted for (1) one year from the date of purchase.

Replacement products will be warranted for the remainder of the one year warranty period or (30) thirty days, whichever is longer.

WHO IS PROTECTED

This warranty is enforceable only by the first consumer purchaser.

WHAT IS AND IS NOT COVERED

Except as specified below, this warranty covers all defects resulting from faulty manufacturing of this product. The following are not covered by the warranty.

1. Any product on which the serial number has been defaced, modified, or removed.
2. Damage, deterioration, or malfunction resulting from :
 - Accident, abuse, misuse, neglect, fire, water, lightning, or other acts of nature, commercial or industrial use, unauthorized product modification, or failure to follow instructions included with the product.
 - Misapplication of service by someone other than the manufacturer's representative.
 - Any shipment damages. (Claims must be made with carrier.)
 - Any other cause which does not relate to a product defect.
3. Cartons, cases, batteries, cabinets, tapes, or accessories used with product.
4. AVerMedia does not warrant that this product will meet your requirements; it is your responsibility to determine the suitability of this product for your purpose.

WHAT WE WILL AND WILL NOT PAY FOR

We will pay labor and material expenses for covered items. However, we will not pay for the following :

1. Removal or installation charges.
2. Shipping charges.
3. Any incidental charges.

EXCLUSION OF DAMAGES

THE MANUFACTURER'S SOLE OBLIGATION AND LIABILITY UNDER THIS WARRANTY IS LIMITED TO THE REPAIR OR REPLACEMENT OF A DEFECTIVE PRODUCT AT OUR OPTION. THE MANUFACTURER SHALL NOT, IN ANY EVENT, BE LIABLE TO THE PURCHASER OR ANY THIRD PARTY FOR ANY INCIDENTAL OR CONSEQUENTIAL DAMAGE (INCLUDING, BUT NOT LIMITED TO, DAMAGES RESULTING FROM INTERRUPTION OF SERVICE AND LOSS OF BUSINESS) OR LIABILITY IN TORT RELATING TO THIS PRODUCT OR RESULTING FROM ITS USE OR POSSESSION.

LIMITATIONS OF IMPLIED WARRANTIES

There are no other oral or written warranties, expressed or implied, including but not limited to those of merchantability or fitness for a particular purpose. Any implied warranties are limited in duration to one year from the date of purchase.

STATE LAW AND YOUR WARRANTY

This warranty gives you specific legal rights, and you may also have other rights granted under state law. These rights vary from state to state.

CONTACT INFORMATION

<http://www.avermedia.com>

<http://www.averdigi.com>